

Installationvorschrift gemäss 16-M-09-100-00  
 Installation selon la 16-M-09-100-00  
 Installation according 16-M-09-100-00

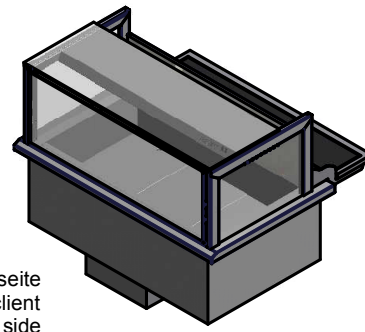
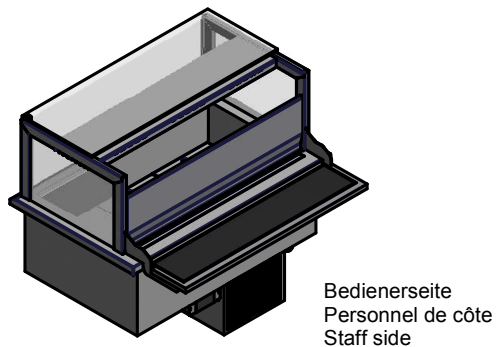

## Culinario Arctis EK

	GN 2/1	GN 3/1	GN 4/1	GN 5/1
<b>Artikel Nr.</b>	3421x01	3431x01	3441x01	3451x01
A1 [mm]	835	1160	1485	1810
A2 [mm]	750	1090	1430	1770
A3 [mm]	725	1050	1375	1700
A4 [mm]	355	355	355	370
<b>Kälteleistung</b>				
Einstellbarer Temperaturbereich [°C]	+4...+12	+4...+12	+4...+12	+4...+12
Kälteleistung bei VT -10°C [W]	370	480	600	700
Kältemittel	R134a	R134a	R134a	R134a
Elektrischer Anschluss	230VAC/PNE	230VAC/PNE	230VAC/PNE	230VAC/PNE
Leistung [W]	405	650	780	870
Max. Nennstrom [A]	1.8	2.8	3.4	3.8
Stecker	Typ12/Schuko	Typ12/Schuko	Typ12/Schuko	Typ12/Schuko
Kabellänge [m]	3	3	3	3
<b>Réfrigération Spécifications</b>				
Plage de température réglable [°C]	+4...+12	+4...+12	+4...+12	+4...+12
Capacité de refroidissement à la température de l'évaporateur 10°C [W]	370	480	600	700
Frigorigène	R134a	R134a	R134a	R134a
Données électrique	230VAC/PNE	230VAC/PNE	230VAC/PNE	230VAC/PNE
Puissance électrique [W]	405	650	780	870
Courant nominal max. [A]	1.8	2.8	3.4	3.8
Fiche	Typ12/Schuko	Typ12/Schuko	Typ12/Schuko	Typ12/Schuko
Longueur du câble [m]	3	3	3	3
<b>Refrigeration specification</b>				
Adjustable temperature range [°C]	+4...+12	+4...+12	+4...+12	+4...+12
Refrigeration capacity @EVAP -10°C [W]	370	480	600	700
Refrigeant	R134a	R134a	R134a	R134a
Electrical connection	230VAC/PNE	230VAC/PNE	230VAC/PNE	230VAC/PNE
electrical power [W]	405	650	780	870
Max. nominal current [A]	1.8	2.8	3.4	3.8
Plug	no Plug	no Plug	no Plug	no Plug
Length of cable [m]	3.0	3.0	3.0	3.0

R2	R1	Aender.				Ers. durch:				
Ind.	Datum	Name	Aenderung	Ind.	Datum	Name	Aenderung	Ers. für:		
A	13.06.2012	mab	Anpa. der Aufbauten					Komm.		
Culinario Arctis GN EK								Gezeich.	Franz	15.02.2011
technisches Datenblatt								Geprüft		
								Massstab		Blatt 1
								%		von 2
								Beer Grill AG CH - 5612 Villmergen Tel.: +41 / (0) 56 618 78 00 Fax: +41 / (0) 56 618 78 49 e-Mail: info@beergill.com		16Ma100-00A

Aenderungen vorbehalten / Sous réserve de modifications / Subject to change without notice

# Glasaufbauten / Constructions en verre / Glass Constructions

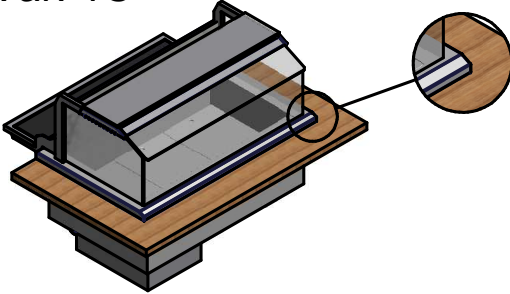
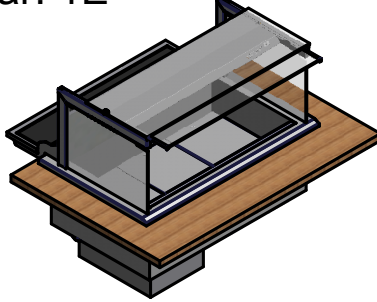
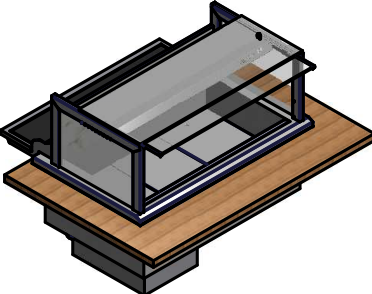
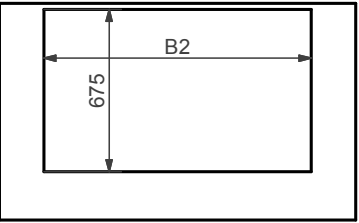
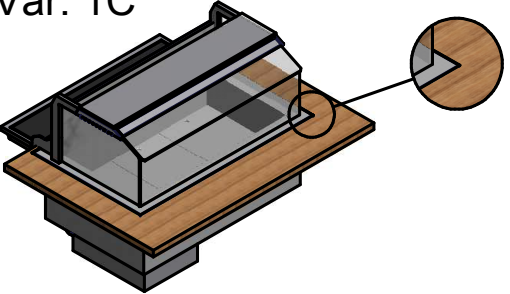
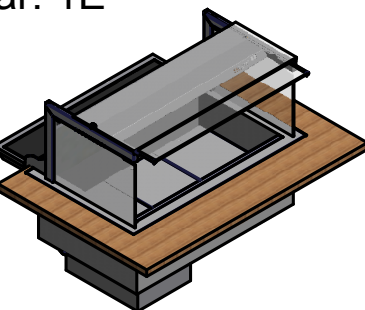
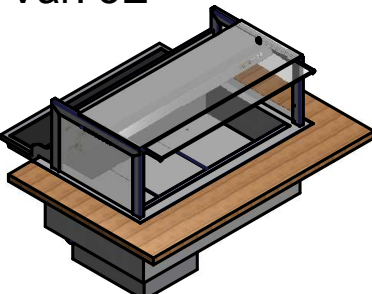
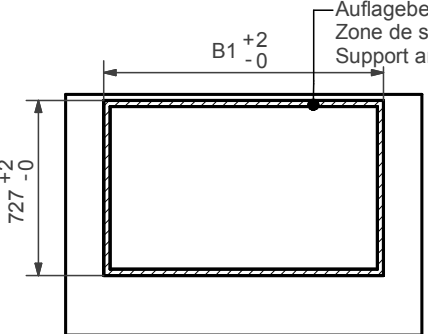
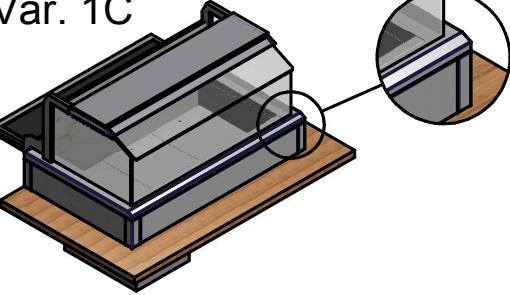
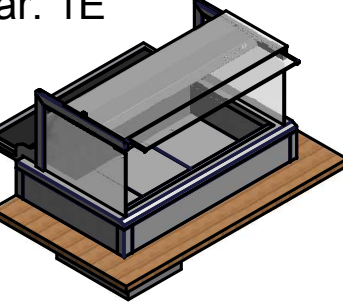
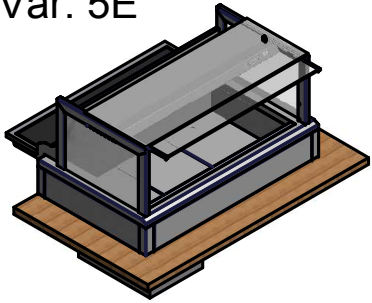
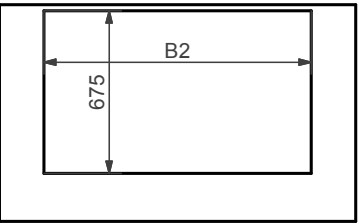
Tischgerät überstehend Modèle de table, encastré Table top model, built-in	<b>Var. 1C</b> 	<b>Var. 1E</b> 	<b>Var. 5E</b> 	
Tischgerät flächenbündig Modèle de table, plan de travail Table top model, flush with table top	<b>Var. 1C</b> 	<b>Var. 1E</b> 	<b>Var. 5E</b> 	
Tischgerät auf Tisch Modèle de table, sur la table Table top model, on table	<b>Var. 1C</b> 	<b>Var. 1E</b> 	<b>Var. 5E</b> 	

Für Einstellungen und Inbetriebnahme der Kühlung ist ausschliesslich die BEER Bedienungs- und Programmieranleitung sowie der Installationsvorschrift 16-M-09-100-00 verbindlich. (Änderung vorbehalten)

Pour ajustage et mettre en service de la réfrigération utilise exclusivement le mode d'emploi et programmation BEER ainsi que le installation instruction 16-M-09-100-00. (Sous réserve de modifications)

For adjusting and start-up of cooling system use exclusively the BEER service- and programming- instruction, as well as the installation instruction 16-M-09-100-00. (Subject to change without notice)

Ausschnittsmasse in Arbeitsfläche				
Diemensio de decoupe dans planche de travail				
Diemension of the table top cut out				
	GN-2/1	GN-3/1	GN-4/1	GN-5/1
B1 [mm]	837	1162	1487	1812
B2 [mm]	787	1112	1437	1762

R2	R1	Aender.		Ers. durch:		
A	13.06.2012	mab	Anpa. der Aufbauten	Ers. für:		
Ind.	Datum	Name	Aenderung	Ind.	Datum	
				Name		
				Aenderung		
				Komm.		
				Gezeich.	Franz	15.02.2011
				Geprüft		
				Massstab		Blatt 2
				%		von 2
<b>Culinario Arctis GN EK</b> <b>technisches Datenblatt</b>				 Beer Grill AG CH - 5612 Villmergen Tel.: +41 / (0) 56 618 78 00 Fax: +41 / (0) 56 618 78 49 e-Mail: info@beergill.com		<b>16Ma100-00A</b>